

Esploso 60122P PT3000

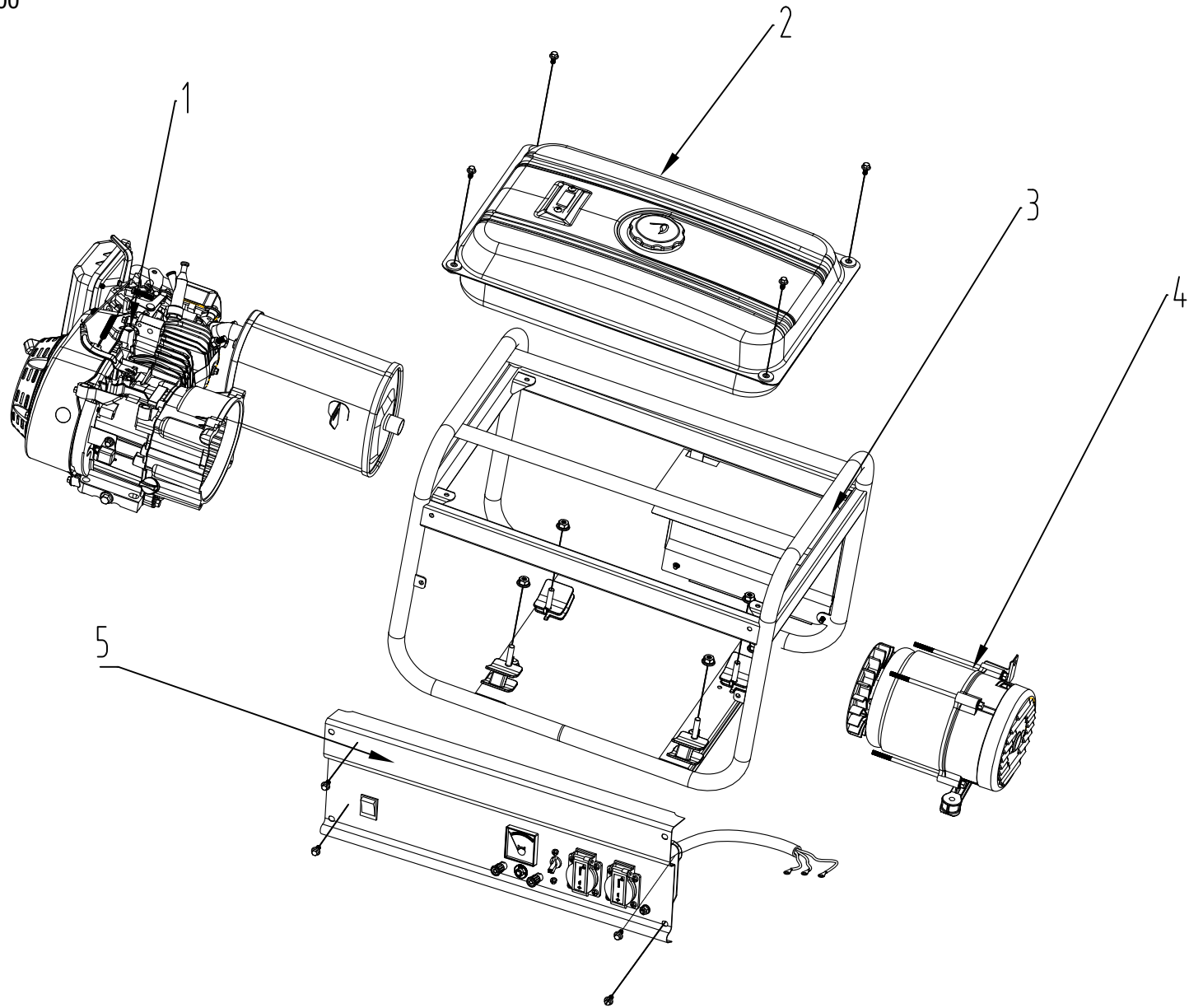

Itemref	Quantity	Title/Name, designation, material, dimension etc	Article No./Reference		
Designed by XXX	Checked by XXX	Approved by - date XXX - 00/00/00	Filename Exploder	Date	Scale 1:1
Generator Exploder			Edition 0		Sheet 1/7

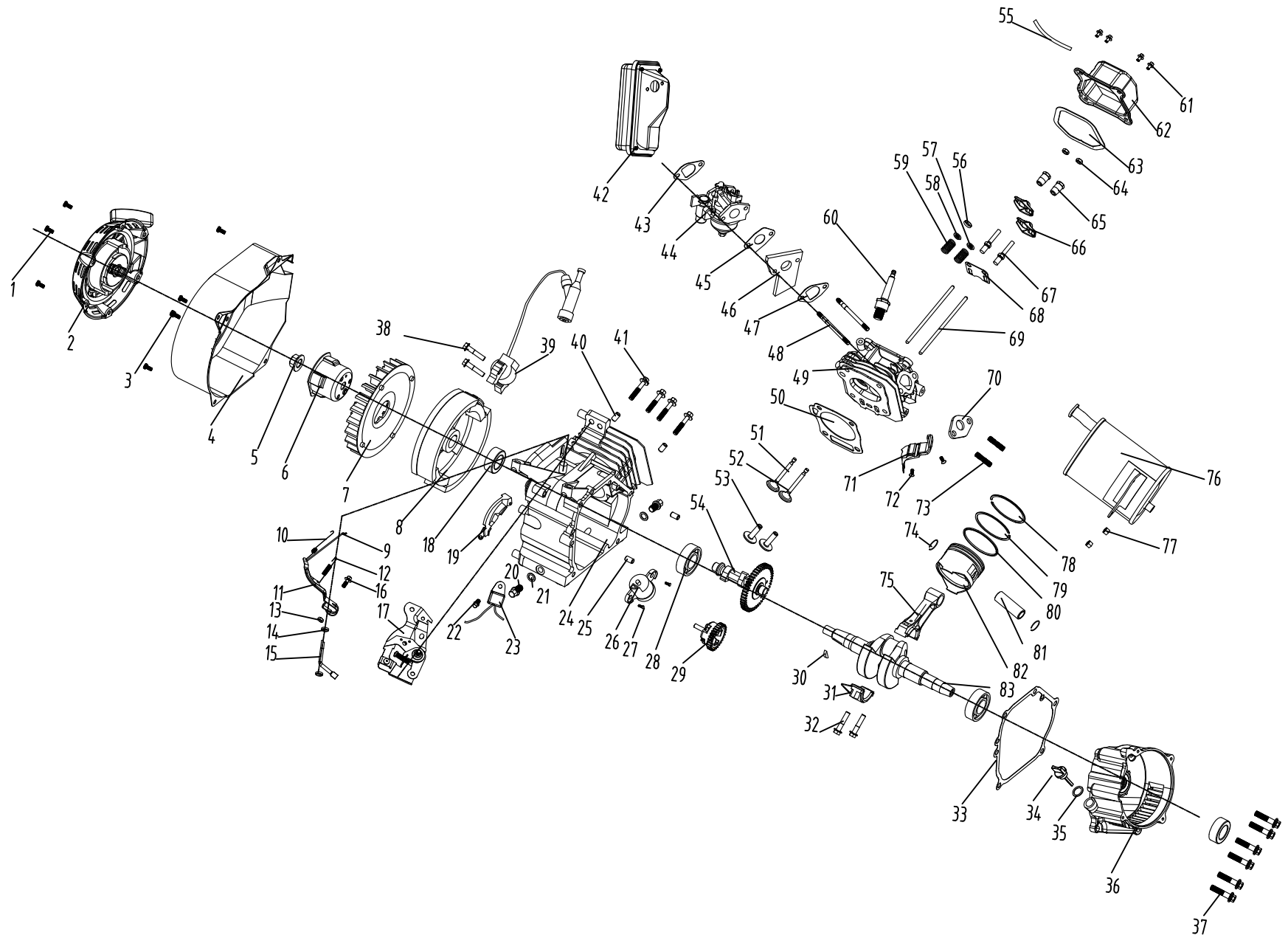

Itemref	Quantity	Title/Name, designation, material, dimension etc		Article No./Reference	
Designed by XXX	Checked by XXX	Approved by - date XXX - 00/00/00	Filename Exploder	Date	Scale 1:1
Gasoline Exploder				Edition 0	Sheet 2/7

Engine Components list for PT2500 3/7

No	English Name	Number	No	English Name	Number
1	Flange Bolt M6×8	3	43	Air cleaner gasket	1
2	Recoil starter	1	44	Carburetor	1
3	Flange Bolt M6×12	4	45	Carburetor gasket	1
4	Fan Cover	1	46	Carburetor Insulator	1
5	Flywheel Nut M14×1.5	1	47	Carburetor Insulator Gasket	1
6	Starting Cup	1	48	Stud Bolt M6×90	2
7	Fan	1	49	Cylinder head	1
8	Flywheel	1	50	Cylinder head gasket	1
9	Governor Pull Rod	1	51	Intake Valve	1
10	Small Governor Spring	1	52	Exhaust Valve	1
11	Governor Arm	1	53	Valve Lifter	2
12	Set Governor Spring	1	54	Camshaft	1
13	Flange Nut M6	1	55	Breather tube	1
14	Gasket 6	1	56	Exhaust Valve Hat	1
15	Governor Lever	1	57	Exhaust Valve Spring Retainer	1
16	Square Bolt M6×21	1	58	Intake Valve Spring Retainer	1
17	Set Governing base	1	59	Valve Spring	2
18	Oil seal	2	60	Sparkplug	1
19	Flywheel Plate	1	61	Flange Bolt M6×12	4
20	Drain Plug	2	62	Cylinder head cover	1
21	Drain Plug Gasket	2	63	Cylinder head cover gasket	1
22	Flange Bolt M6×12	1	64	Rocker Nut	2
23	Interdiction Organ	1	65	Rocker adjust Nut	2
24	Crankcase	1	66	Rocker arm	2
25	Crankcase Pin φ8×14	2	67	Rocker Bolt	2
26	Oil Sensor	1	68	Push-Rod Keep Frame	1
27	Flange Bolt M6×12	2	69	Push-Rod	2
28	Bearing 6205	2	70	Exhaust pipe Gasket	1
29	Governor Gear	1	71	Lead Wind Cover	1
30	Flywheel Key	1	72	Flange Bolt M6×8	2
31	Connecting rod Cover	1	73	Stud bolt M8×32	2
32	Connecting rod Bolt	2	74	Piston pin clip	2
33	Crankcase Gasket	1	75	Connecting rod body	1
34	Oil ruler	1	76	Muffler	1
35	Oil ruler Gasket	1	77	Nut M8	2
36	High Crankcase cover	1	78	Top compression ring	1
37	Flange Bolt M8×33	6	79	Second compression ring	1
38	Flange Bolt M6×25	2	80	Oil ring	1
39	High Voltage Bag	1	81	Piston pin	1
40	Cylinder Head Pin φ8×16	2	82	Piston	1
41	Flange Bolt M8×55	4	83	Crankshaft	1
42	Air Cleaner	1			

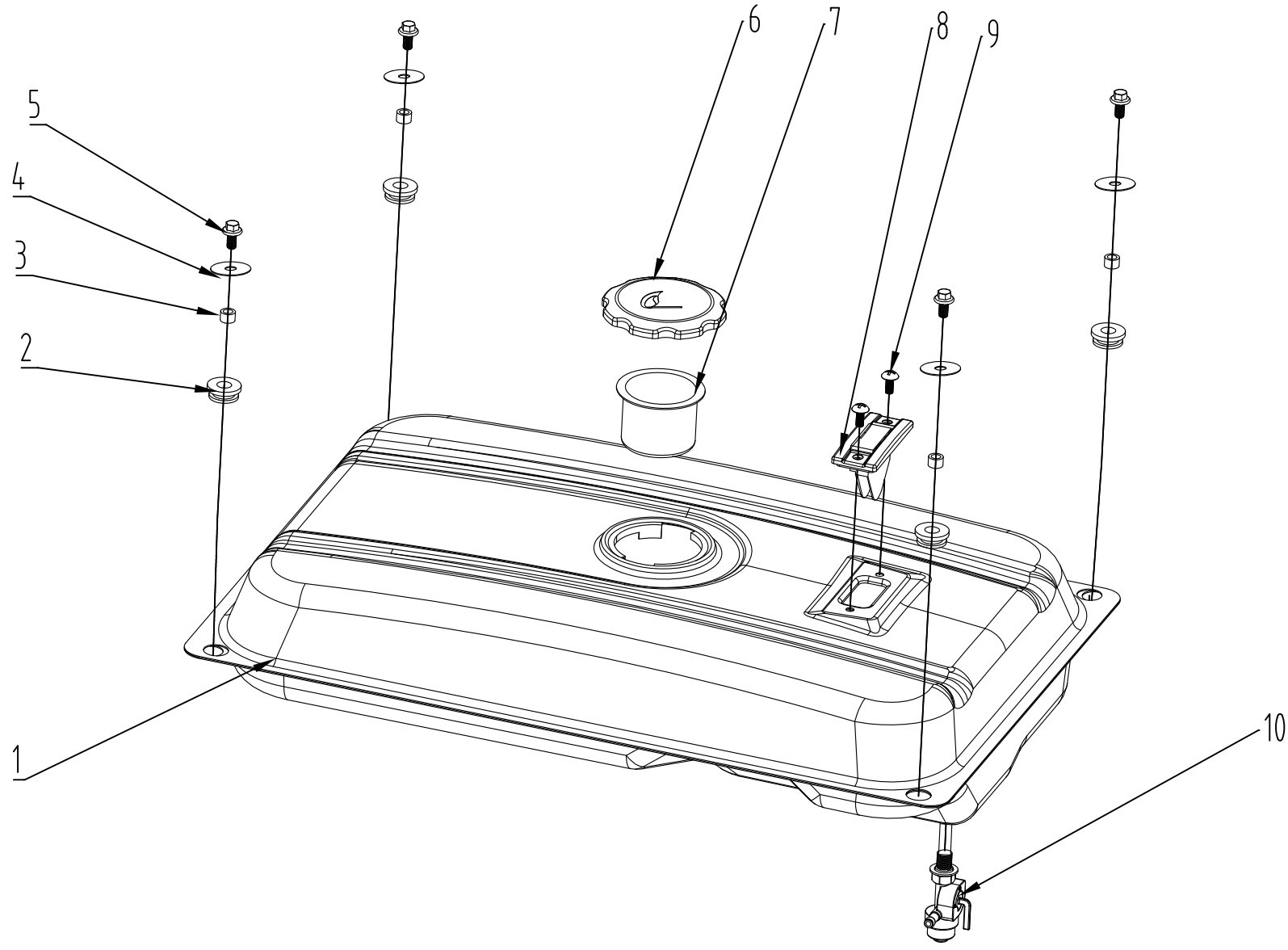

4	Iron gasket	8	Fuel Meter		
3	Iron cover	7	Filter net		
2	Rubber gasket	6	Fuel tank Cover	10	Fuel switch
1	Fuel tank	5	Bolt M6×25	9	Bolt M5×12
No	English	No	English	No	English

Itemref	Quantity	Title/Name, designation, material, dimension etc	Article No./Reference
Designed by XXX	Checked by XXX	Approved by - date XXX - 00/00/00	Filename Exploder
Date			Scale 1:1
Fuel tank parts Exploder			Edition 0
			Sheet 4/7

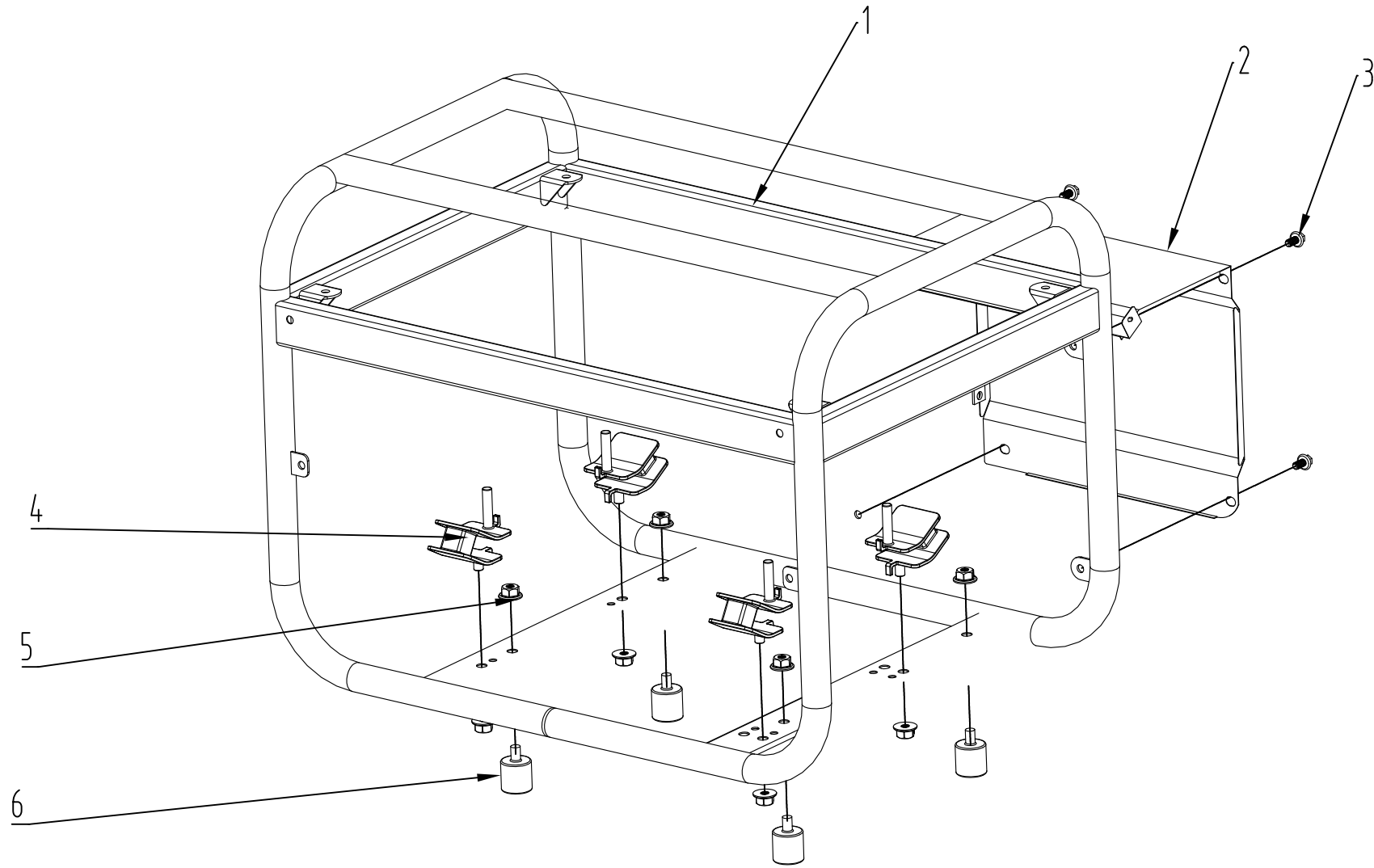

2	Guard plate	4	Shake Feet	6	Rubber feet
1	Frame	3	Bolt M6×12	5	Nut M8
Number	English	Number	English	Number	English

Itemref	Quantity	Title/Name, designation, material, dimension etc		Article No./Reference	
Designed by XXX	Checked by XXX	Approved by - date XXX - 00/00/00	Filename Exploder	Date	Scale 1:1
Frame parts Exploder				Edition 0	Sheet 5/7

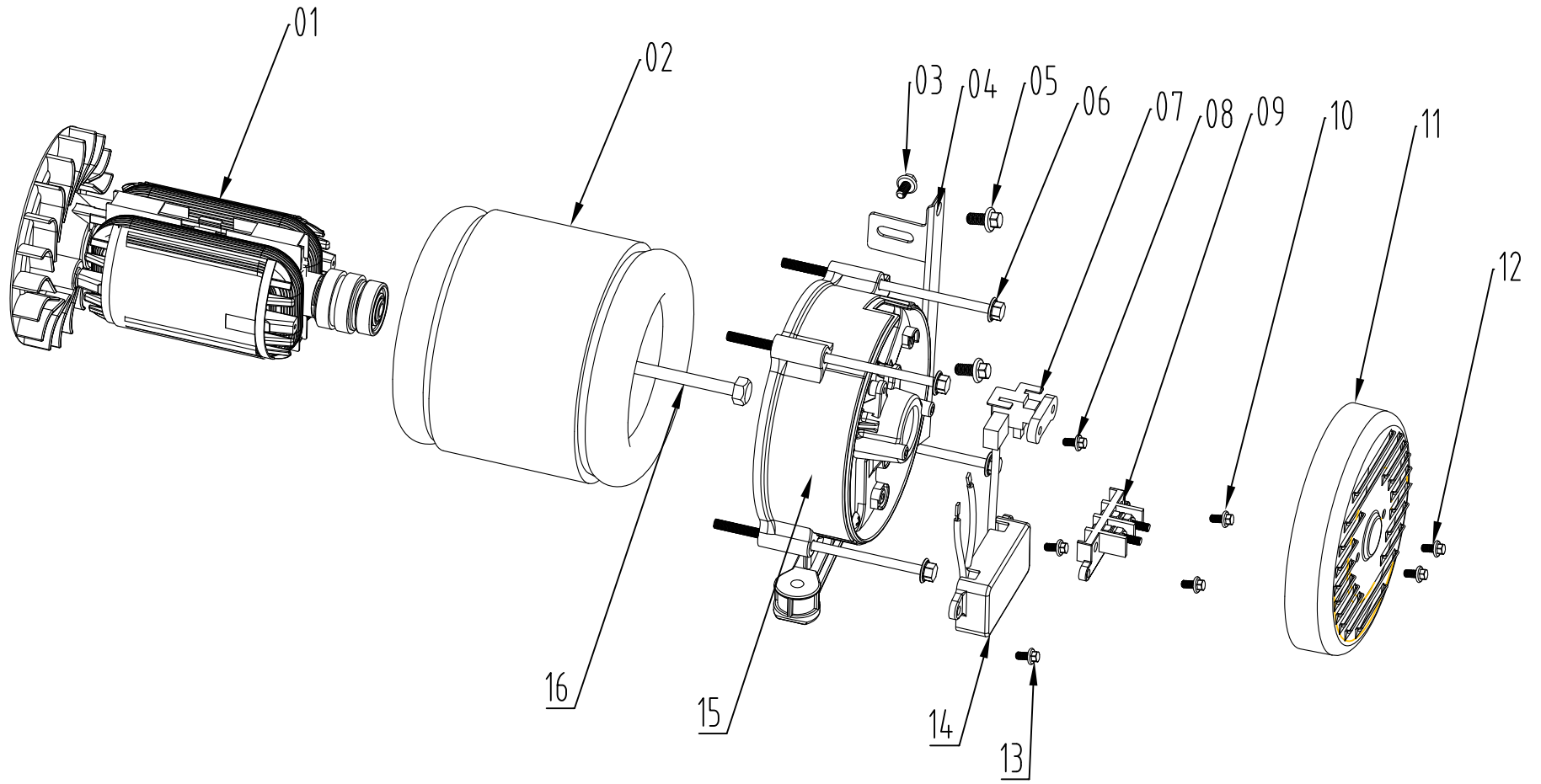

4	Hang feet	1	8	Carbon brush Bolt M5×16	1	12	Back Cover bolt M5×8	2	16	Rotor bolt	1
3	Bolt M6×12	1	7	Carbon brush	1	11	Back Cover	1	15	Generator End Bell	1
2	Stator	1	6	Stator bolt	4	10	Junction Box Bolt M5×12	2	14	AVR	1
1	Rotor	1	5	Bolt M8×16	2	9	Junction Box	1	13	AVR Bolt M5×12	2
No	English	Number	No	English	Number	No	English	Number	No	English	Number

Itemref	Quantity	Title/Name, designation, material, dimension etc			Article No./Reference	
Designed by XXX	Checked by XXX	Approved by - date XXX - 00/00/00	Filename Exploder	Date	Scale 1:1	
Electrical machine Exploder				Edition 0	Sheet 6/7	

A
B
C
D
E
F
G
H

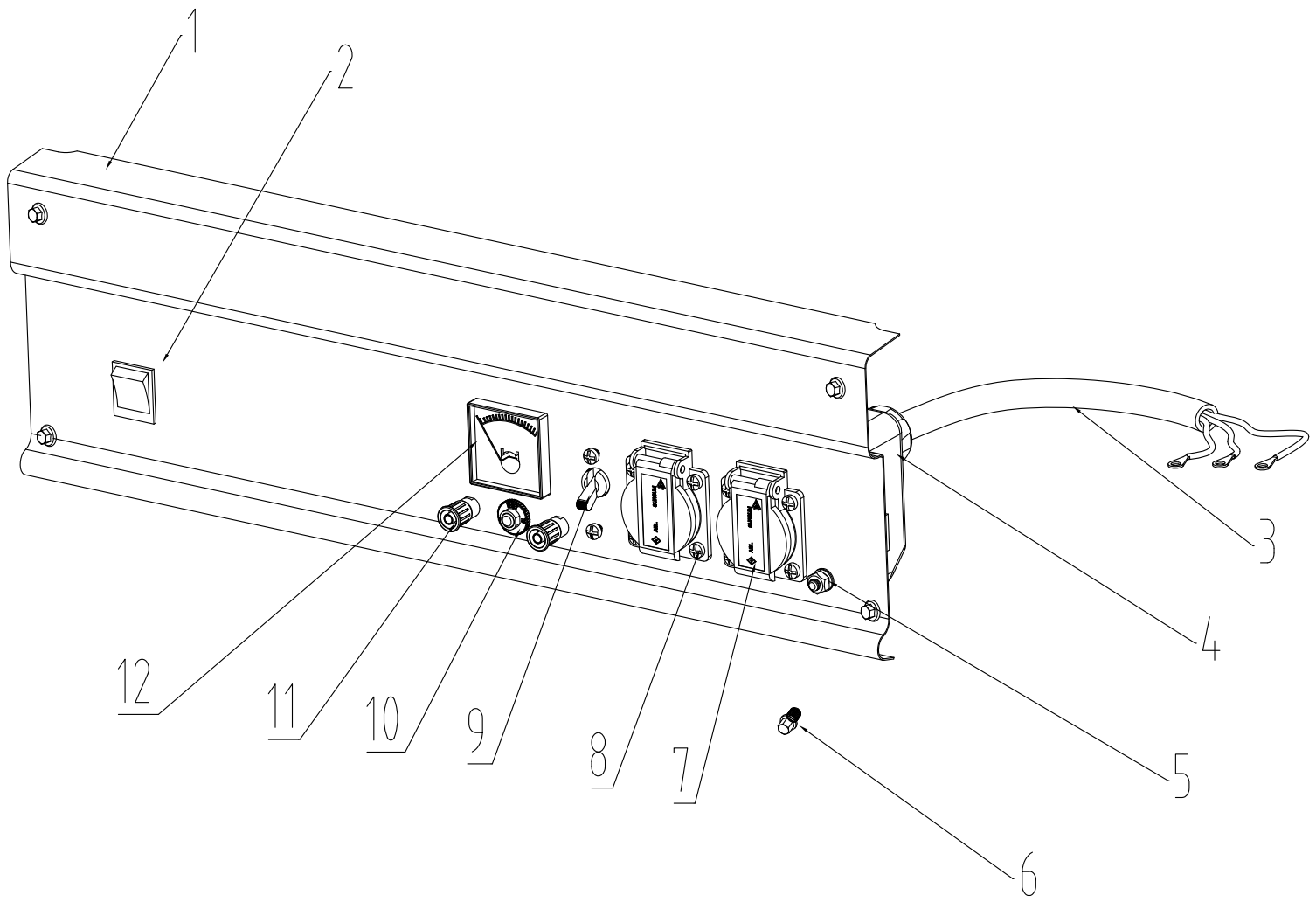

5	Earth bolt	10	DC Breaker		
4	Panel back cover	9	AC Breaker		
3	Inlet wire	8	Bolt M4×12		
2	Switch	7	AC Socket	12	Voltage meter
1	Control panel	6	Bolt M6×12	11	DC Terminal.
Number	English	Number	English	Number	English

Itemref	Quantity	Title/Name, designation, material, dimension etc			Article No./Reference	
Designed by XXX	Checked by XXX	Approved by - date XXX - 00/00/00	Filename Exploder	Date	Scale 1:1	
Control panel Exploder				Edition 0	Sheet 7/7	

Legenda esploso 60122P / PT3000

Parte nr.	Codice	Descrizione (ITA)	Description (ENG)	EAN
engine: from 43 to 47	94150	Carburatore	Carburetor including gaskets	8028815941501
Control panel: 20	94300	Interruttore corrente AC ON/OFF	AC breaker	8028815943000
Fuel tank: from 1 to 9	94517	Serbatoio completo	Full fuel tank assembly	8028815945172
Fuel tank: 10	94379	Rubinetto carburante	Fuel switch	8028815943796